

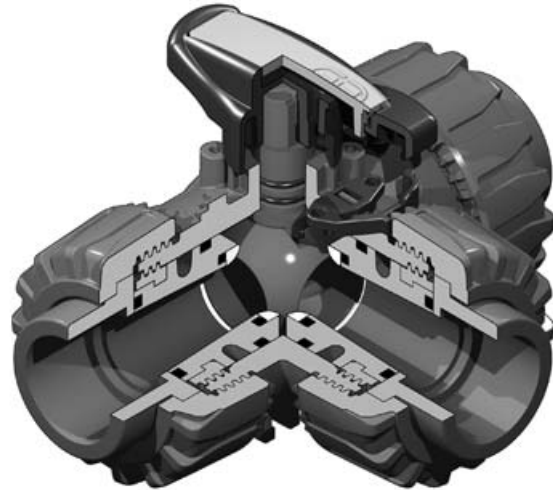

TKD SERIES 3-WAY BALL VALVES

Data Sheet



< STANDARDS >



ASTM D1784
ASTM D2466
ASTM D2467
ASTM D2464
ASTM F1498



ANSI B1.20.1



NSF 61

introduction

IPEX TKD Series 3-Way Ball Valves can be used for flow diverting, mixing, or on/off isolation. They will replace a Tee + 2 valve linkage assembly at reduced cost and space, along with shorter installation and maintenance time. The patented seat stop carrier allows for in-line microadjustment of the ball seating, and features o-ring cushioning to minimize wear and prevent seizing. The TKD also includes our patented DUAL BLOCK® locking union nut system, which ensures the nuts are held in position even under severe service conditions such as high vibration or thermal expansion. Integral mounting flange and bracketing allows for direct actuation and simple support, while a locking handle can prevent improper positioning. TKD Series 3-Way Ball Valves are part of our complete Xirtec®140 systems of pipe, valves and fittings, engineered and manufactured to our strict quality, performance, and dimensional standards.

Valve Availability

Body Material:	PVC, CPVC
Size Range:	1/2" through 2"
Port Configuration:	Full port with T or L flow pattern
Pressure:	232psi
Seats:	Teflon® (PTFE)
Seals:	EPDM or FPM
End Connections:	Socket (IPS), Threaded (FNPT)

Sample Specification



1.0 Ball Valves – TKD

1.1 Material

- The valve body, stem, ball, end connectors, and unions shall be made of PVC compound which shall meet or exceed the requirements of cell classification 12454 according to ASTM D1784.
- The valve body, stem, ball and unions shall be made of Corzan® CPVC compound which shall meet or exceed the requirements of 23447 according to ASTM D1784.
- These compounds shall conform to the requirements of NSF 61 standard for potable water.

1.2 Seats

- The ball seats shall be made of Teflon® (PTFE).

1.3 Seals

- The o-ring seals shall be made of EPDM which shall be listed with NSF to standard 61 for potable water.
- or
- The o-ring seals shall be made of FPM which shall be listed with NSF to standard 61 for potable water.

1.4

- All other wetted and non-wetted parts of the valves shall be listed with NSF to Standard 61 for potable water.

2.0 Connections

2.1 Socket style

- The IPS socket PVC end connectors shall conform to the dimensional standards ASTM D2466 and ASTM D2467.
- or
- The IPS socket CPVC end connectors shall conform to the dimensional standard ASTM F439.

2.2 Threaded style

- The female NPT threaded PVC end connectors shall conform to the dimensional standards ASTM D2464, ASTM F1498 and ANSI B1.20.1.
- or
- The female NPT threaded CPVC end connectors shall conform to the dimensional standards ASTM F437, ASTM F1498, and ANSI B1.20.1.

Sample Specification (cont'd)



3.0 Design Features

- All valves shall be true union at all three ports.
- All sizes shall be full port.
- Valve design shall permit positive shutoff of any of the three ports.
- Balls shall be of T-port or L-port design (specifier must select one).
- The valve shall have blocking seat supports at all three ports.
- The threaded carrier (ball seat support) shall be adjustable with the valve installed.
- The valve body, union nuts, and carrier shall have deep square style threads for increased strength.
- The ball shall be machined smooth to minimize wear on valve seats.
- All valve seats shall have o-ring backing cushions to compensate for wear and prevent seizure of the ball.
- The thickness of the valve body shall be the same at all three ports.
- The stem design shall feature a shear point above the o-ring to maintain system integrity in the unlikely event of a stem breakage.
- The valve shall include the DUAL BLOCK® union nut locking mechanism.
- The handle shall incorporate an optional feature to allow the valve position to be secured with a padlock.
- The handle shall incorporate a removable tool for adjustment of the threaded carrier.
- The top of the stem shall incorporate molded features to indicate port location and ball position.
- All valves shall have integrally molded mounting flanges for support and actuation.

3.1 Pressure Rating

- All valves shall be rated at 232psi at 73°F (23°C).

3.2 Markings

- All valves shall be marked to indicate size, material designation, and manufacturer's name or trade mark.

3.3 Color Coding

- All PVC valves shall be color-coded dark grey.
- or All CPVC valves shall be color-coded light grey.

4.0 All valves shall be Xirtec®140 or Corzan® by IPEX or approved equal.

Valve Selection

Size (inches)	Body Material	Port Style	O-ring Material	IPEX Part Number		Pressure Rating @ 73°F
				IPS Socket	FNPT Threaded	
1/2	PVC	T	EPDM		253850	232 psi
		L	FPM		253862	
	CPVC	T	EPDM		253844	
		L	FPM		253856	
3/4	PVC	T	EPDM		253899	
		L	FPM		253907	
	CPVC	T	EPDM		253893	
		L	FPM		253905	
1	PVC	T	EPDM		253851	
		L	FPM		253863	
	CPVC	T	EPDM		253845	
		L	FPM		253857	
1-1/4	PVC	T	EPDM		253900	
		L	FPM		253908	
	CPVC	T	EPDM		253894	
		L	FPM		253922	
1-1/2	PVC	T	EPDM		253852	
		L	FPM		253864	
	CPVC	T	EPDM		253846	
		L	FPM		253858	
2	PVC	T	EPDM		253901	
		L	FPM		253909	
	CPVC	T	EPDM		253895	
		L	FPM		253906	
1-1/4	PVC	T	EPDM		253853	
		L	FPM		253865	
	CPVC	T	EPDM		253847	
		L	FPM		253859	
1-1/2	PVC	T	EPDM		253902	
		L	FPM		253910	
	CPVC	T	EPDM		253896	
		L	FPM		253923	
1-1/2	PVC	T	EPDM		253854	
		L	FPM		253866	
	CPVC	T	EPDM		253848	
		L	FPM		253860	
2	PVC	T	EPDM		253903	
		L	FPM		253911	
	CPVC	T	EPDM		253897	
		L	FPM		253924	
2	PVC	T	EPDM		253855	
		L	FPM		253867	
	CPVC	T	EPDM		253849	
		L	FPM		253861	
2	PVC	T	EPDM		253904	
		L	FPM		253912	
	CPVC	T	EPDM		253898	
		L	FPM		253925	

Note: Flanged valves available upon request.

Material:

PVC CPVC

Port:

T L

Size (inches):

1/2 1-1/4

3/4 1-1/2

1 2

Seals:

EPDM

FPM

End Connections:

Socket (IPS)

Threaded (FNPT)

IPEX Part Number:

Technical Data

dimensions

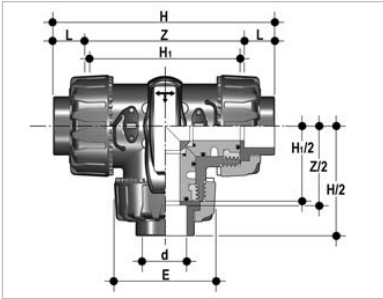

IPS Socket Connections - Dimension (inches)							
Size (d)	DN	PN	E	H	H ₁	L	Z
1/2	0.59	0.63	2.13	5.20	3.15	0.91	3.43
3/4	0.79	0.63	2.56	6.27	3.94	1.00	4.26
1	0.98	0.63	2.87	6.85	4.33	1.13	4.59
1-1/4	1.26	0.63	3.39	8.07	5.16	1.26	5.55
1-1/2	1.57	0.63	3.86	8.96	5.83	1.38	6.20
2	1.97	0.63	4.80	10.51	7.05	1.50	7.50

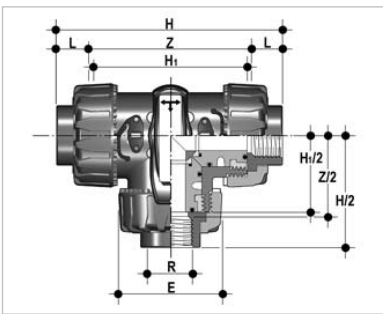

Female NPT Socket Connections - Dimension (inches)							
Size (R)	DN	PN	E	H	H ₁	L	Z
1/2	0.59	0.63	2.13	4.96	3.15	0.71	3.56
3/4	0.79	0.63	2.56	5.76	3.94	0.71	4.35
1	0.98	0.63	2.87	6.56	4.33	0.89	4.78
1-1/4	1.26	0.63	3.39	7.71	5.16	0.99	5.73
1-1/2	1.57	0.63	3.86	8.32	5.83	0.97	6.38
2	1.97	0.63	4.80	9.99	7.05	1.17	7.66

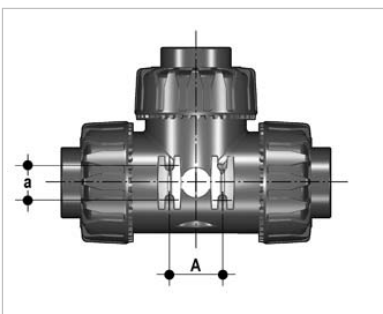

Mounting Flanges - Dimension (inches)			
Size	DN	a	A
1/2	0.59	0.79	1.22
3/4	0.79	0.79	1.22
1	0.98	0.79	1.22
1-1/4	1.26	1.18	1.97
1-1/2	1.57	1.18	1.97
2	1.97	1.18	1.97

Technical Data (cont'd)

weights



Size (inches)	Approximate Weight (lbs)	
	IPS Socket	FNPT Threaded
1/2	0.68	0.68
3/4	1.21	1.21
1	1.74	1.74
1-1/4	2.81	2.81
1-1/2	3.66	3.66
2	6.17	6.17

pressure – temperature ratings

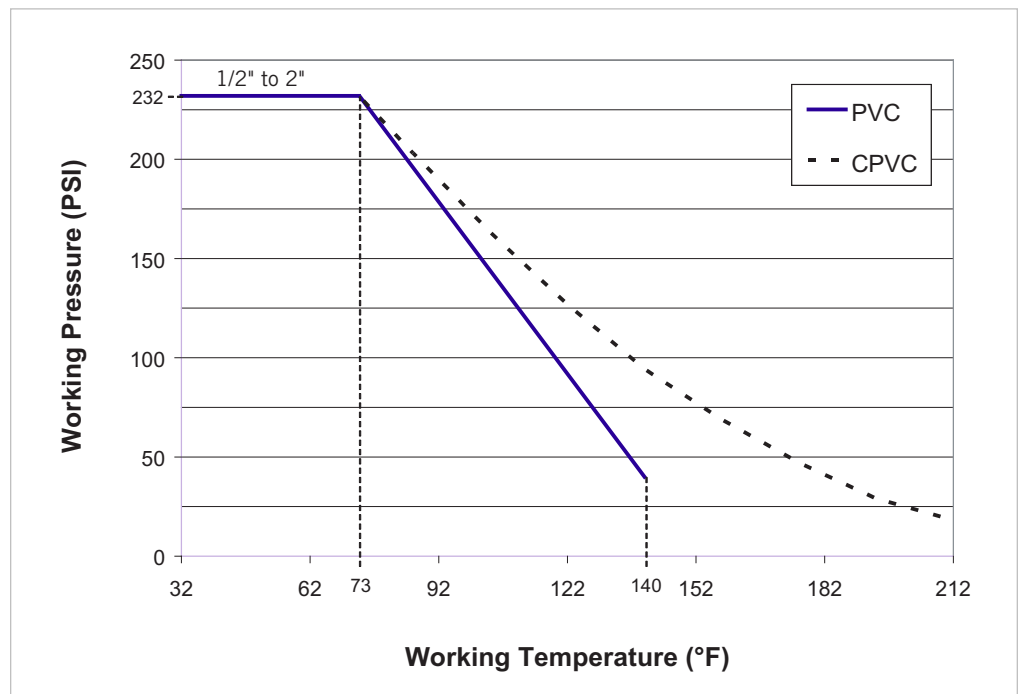

Technical Data (cont'd)

operating positions



Position	T-Port	L-Port
0°	mixing	diverting
90°	diverting	closed
180°	straight flow	closed
270°	diverting	diverting

T-Port

position

L-Port

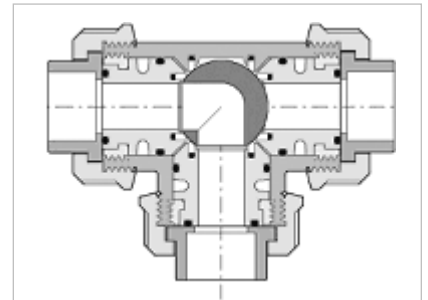
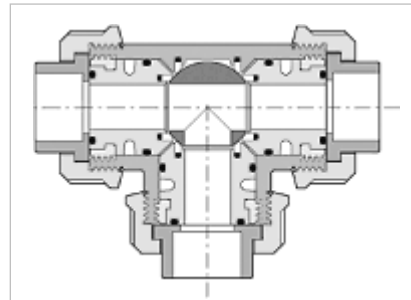

0°

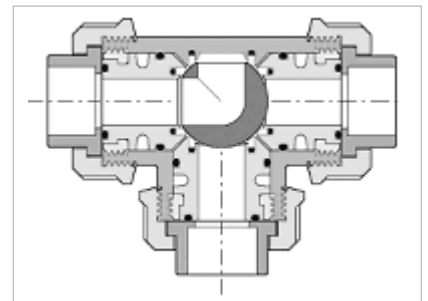
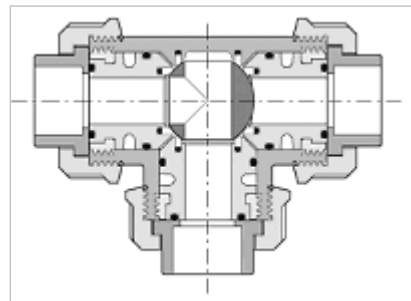

90°

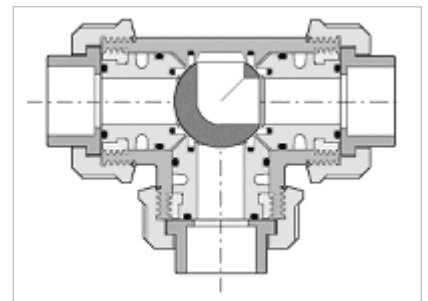
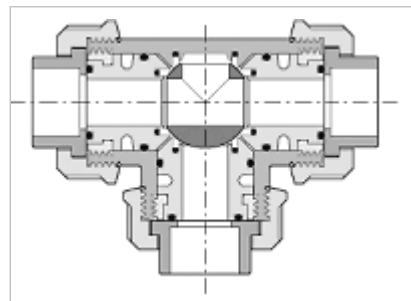

180°

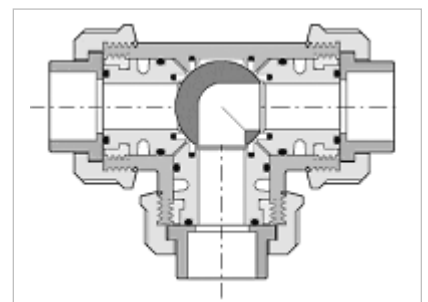
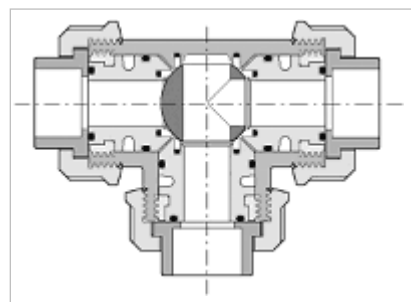

270°

Technical Data (cont'd)

flow coefficients



The flow coefficient (CV) represents the flow rate in gallons per minute (GPM) at 68°F for which there is a 1 psi pressure drop across the valve in the fully open position. These values are determined from an industry standard testing procedure which uses water as the flowing media (specific gravity of 1.0). To determine specific flow rate and pressure loss scenarios, one can use the following formula:

$$f = sg \times \left(\frac{Q}{C_v} \right)^2$$

Where,

f is the pressure drop (friction loss) in psi,

sg is the specific gravity of the fluid,

Q is the flow rate in GPM,

C_v is the flow coefficient.

Size	C _v Value				
	Position				
	A	B	C	D	E
1/2	3.85	2.45	4.55	13.7	5.11
3/4	9.50	6.65	10.2	26.6	10.5
1	14.4	9.80	17.2	53.2	18.6
1-1/4	27.3	18.9	32.2	73.5	33.3
1-1/2	33.3	23.1	42.0	119	43.4
2	63.0	43.4	84.0	224	85.4

pressure loss chart

Position A:

- T-Port
- Center Inlet
- Diverting Flow

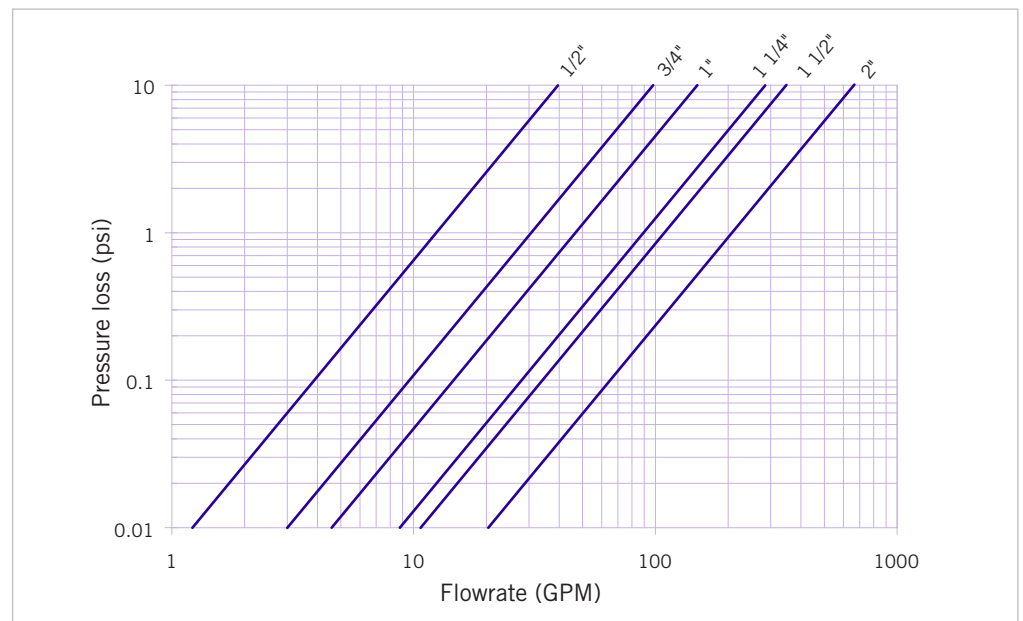
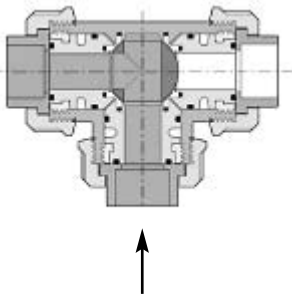

Technical Data (cont'd)

pressure loss charts (cont'd)

Position B:

- T-Port
- Center Inlet
- Separating Flow

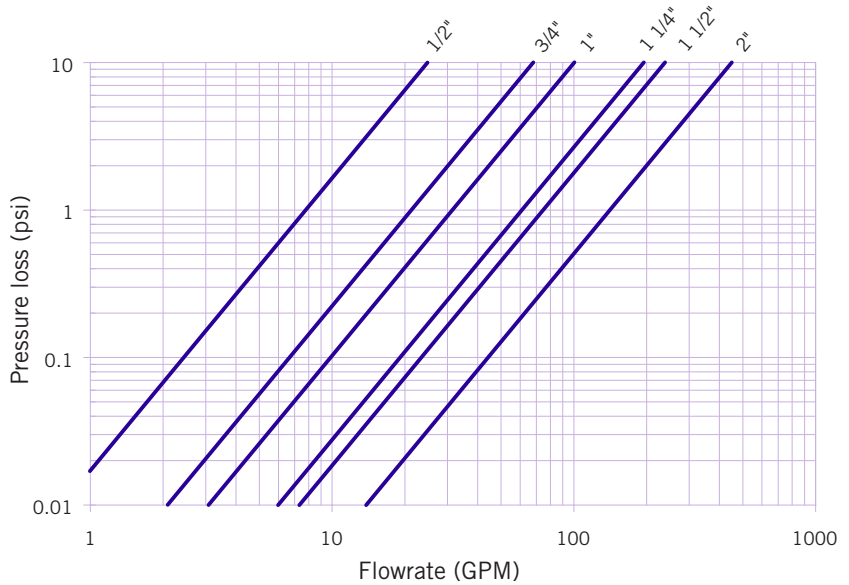
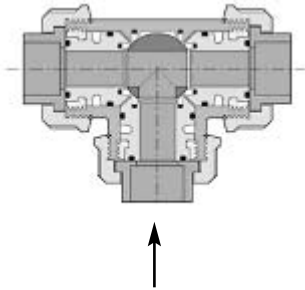

Position C:

- T-Port
- Side Inlet
- Diverting Flow

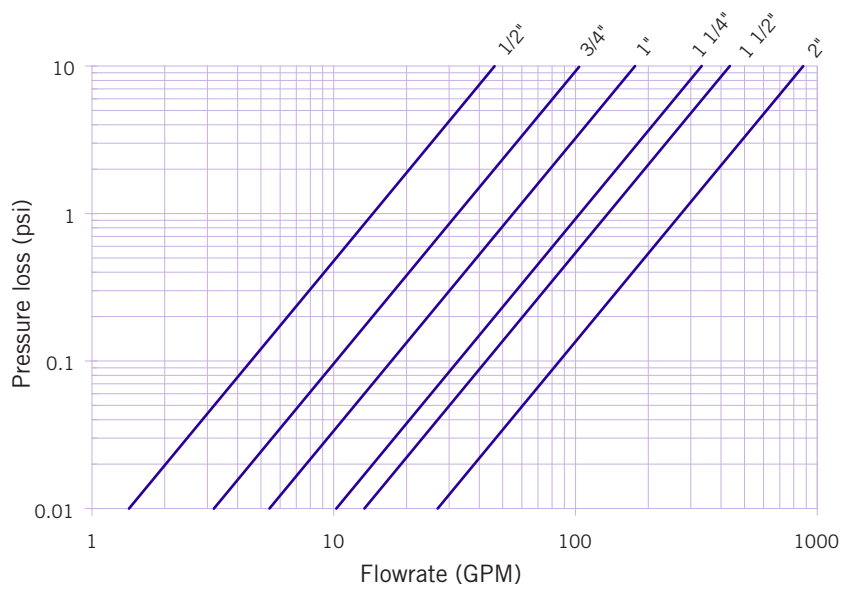
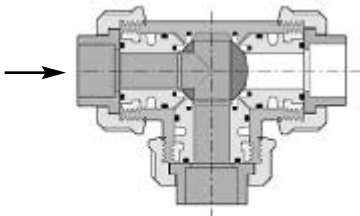

Technical Data (cont'd)

pressure loss charts (cont'd)

Position D:

- T-Port
- Side Inlet
- Straight Flow

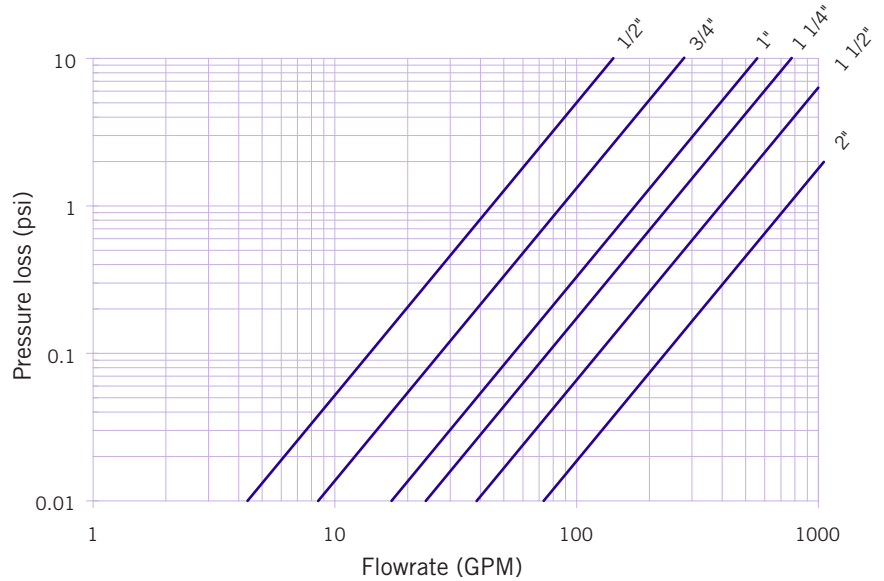
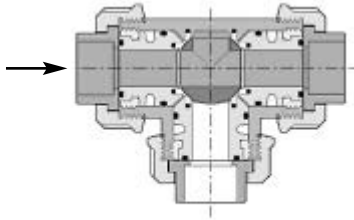

Position E:

- L-Port
- Any Inlet
- Diverting Flow

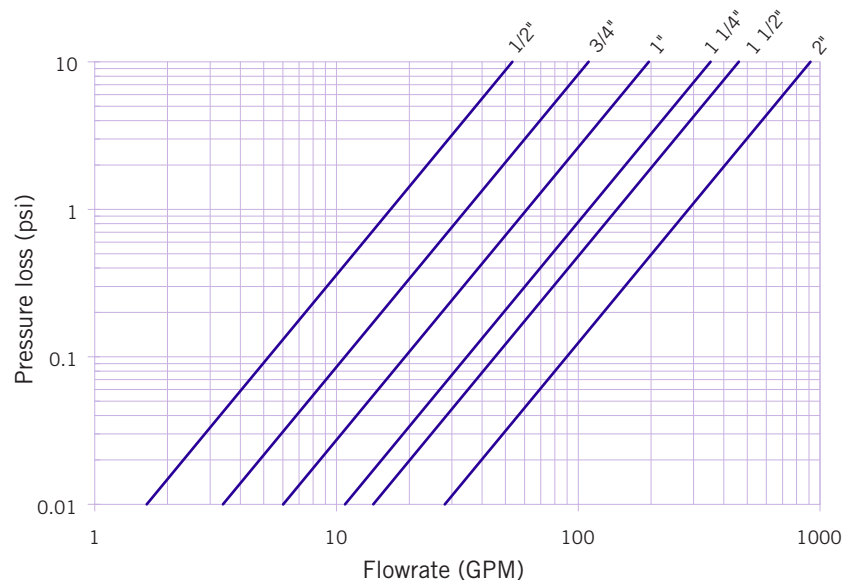
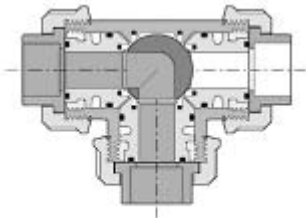

Components

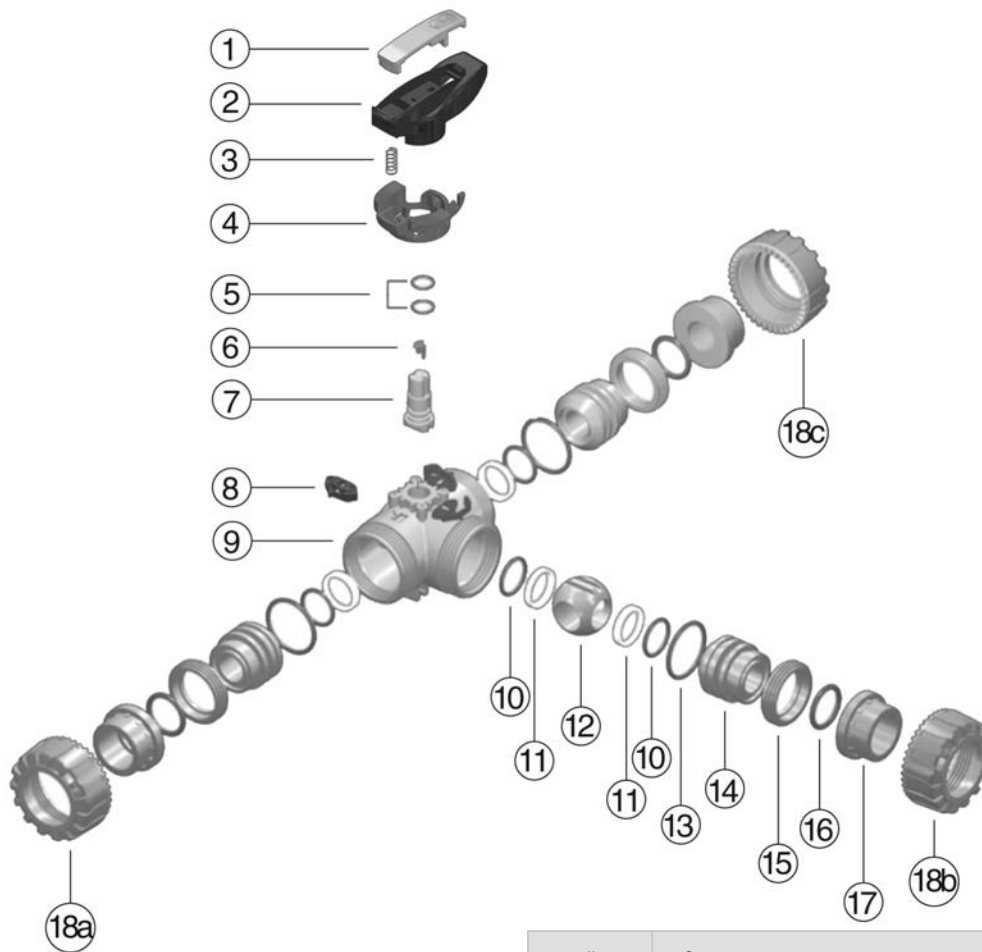

#	Component	Material	Qty
1	insert	PVC	1
2	handle	HI-PVC	1
3	spring (SHKD)	Stainless Steel	1
4**	safety handle block (SHKD)	PP-GR	1
5*	stem o-rings	EPDM / FPM	2
6	position indicator	POM	1
7	stem	PVC / CPVC	1
8	Dual Block®	POM	3
9	body	PVC / CPVC	1
10*	support o-ring for ball seat	EPDM / FPM	4
11*	ball seat	PTFE	4
12	ball	PVC / CPVC	1
13	radial seal o-ring	EPDM / FPM	3
14	support for ball seat	PVC / CPVC	3
15	stop ring	PVC / CPVC	3
16*	socket seal o-ring	EPDM / FPM	3
17*	end connector	PVC / CPVC	3
18abc	union nuts	PVC / CPVC	3

* Spare parts available.

** Optional feature

Installation Procedures



1. For socket and threaded style connections, remove the union nuts (part #18 on previous page) and slide them onto the pipe. For flanged connections, remove the union nut / flange assemblies from the valve.
2. Please refer to the appropriate connection style sub-section:
 - a. For socket style, solvent cement the end connectors (17) onto the pipe ends. For correct joining procedure, please refer to the section entitled, *“Joining Methods – Solvent Cementing”* in the IPEX Industrial Technical Manual Series, *“Volume I: Vinyl Process Piping Systems”*. **Be sure to allow sufficient cure time before continuing with the valve installation.**
 - b. For threaded style, thread the end connectors (17) onto the pipe ends. For correct joining procedure, please refer to the section entitled, *“Joining Methods – Threading”* in the IPEX Industrial Technical Manual Series, *“Volume I: Vinyl Process Piping Systems”*.
 - c. For flanged style, join the union nut / flange assemblies to the pipe flanges. For correct joining procedure, please refer to the section entitled, *“Joining Methods – Flanging”* in the IPEX Industrial Technical Manual Series, *“Volume I: Vinyl Process Piping Systems”*.
3. Open and close the valve to ensure that the seat supports (14) are at the desired adjustment. If adjustment is required, remove the insert tool (1) from the handle (2). Line up the moldings on the tool with the slots in the seat supports. Tighten or loosen to the desired position then replace the tool on the handle. **For correct alignment of the ball and seat support system, adjustment should begin with the center port.**
4. Ensure that the socket o-rings (16) are properly fitted in their grooves then carefully place the valve in the system between the end connections. If anchoring is required, fix the valve to the supporting structure via the integral mounting flange on the bottom of the valve body (9).
5. Tighten the three union nuts. Hand tightening is typically sufficient to maintain a seal for the maximum working pressure. **Over-tightening may damage the threads on the valve body and/or the union nut, and may even cause the union nut to crack.**
6. Check the installation of the dedicated lock nut device DUAL BLOCK® (8) on the valve body.
7. Open and close the valve to ensure that the cycling performance is adequate. If adjustment is required, loosen the union nuts, remove the valve from the system, and then continue from Step 3.

Valve Maintenance

disassembly

1. If removing the valve from an operating system, isolate the valve from the rest of the system. **Be sure to depressurize and drain the isolated branch and valve before continuing.**
2. Unlock the Dual Block® system by compressing the lever (8). Loosen the three union nuts (18) and drop the valve out of the line. If retaining the socket o-rings (16), take care that they are not lost when removing the valve from the line.
3. To disassemble, rotate the handle (2) to the following position:
 - a. For T-Port valves, the three arrows must line up with the three valve ports (The valve must be open at all three ports).
 - b. For L-Port valves, the two arrows must line up with ports “a” and “b” (see component diagram).
4. Remove the insert tool (1) from the handle then line up the moldings on the tool with the slots in the seat supports (14). Loosen and remove all three seat supports from the valve body (9).
5. Remove the ball (12) from the valve body while taking care not to score or damage the outer surface.
6. Remove the handle from the stem (7) by pulling upwards. To remove the stem, push it into the valve body from above.
7. Remove the seats (11), backing o-rings (10), and body o-rings (13) from the seat supports.
8. Remove the seat and backing o-ring from the inside of the valve body.
9. Remove the stem o-rings (5).
10. The valve components can now be checked for problems and/or replaced.

assembly

Note: Before assembling the valve components, it is advisable to lubricate the o-rings with a water soluble lubricant. **Be sure to consult the "IPEX Chemical Resistance Guide" and/or other trusted resources to determine specific lubricant-rubber compatibilities.**

1. Properly fit the stem o-rings (5) in the grooves on the stem (7), then insert the stem from the inside of the valve body (9).
2. Line up the markings on the stem with the ports in the valve body.
3. Replace the backing o-ring (10) and seat (11) at the back of the valve body.
4. Insert the ball (12) into the valve body while ensuring that the ports line up with the markings on the stem.
5. Ensure that all body o-rings (13), backing o-rings, and seats are properly fitted on the three seat supports (14). **Starting with the center port**, tighten each support into the valve body using the insert tool (1).
6. Replace the handle (2) on the stem while ensuring that the position markings on the handle line up with those on the stem. Replace the insert tool on the handle.
7. Properly fit the socket o-rings (16) in their respective grooves.
8. Place the end connectors (17) into the union nuts (18), then thread onto the valve body taking care that the socket o-rings remain properly fitted in their grooves.



Testing and Operating



The purpose of system testing is to assess the quality of all joints and fittings to ensure that they will withstand the design working pressure, plus a safety margin, without loss of pressure or fluid. Typically, the system will be tested and assessed in sub-sections as this allows for improved isolation and remediation of potential problems. With this in mind, the testing of a specific installed valve is achieved while carrying out a test of the overall system.

An onsite pressure test procedure is outlined in the IPEX Industrial Technical Manual Series, *“Volume I: Vinyl Process Piping Systems”* under the section entitled, *“Testing”*. The use of this procedure should be sufficient to assess the quality of a valve installation. **In any test or operating condition, it is important to never exceed the pressure rating of the lowest rated appurtenance in the system.**

Important points:

- Never test thermoplastic piping systems with compressed air or other gases including air-over-water boosters.
- When testing, do not exceed the rated maximum operating pressure of the valve.
- Avoid the rapid closure of valves to eliminate the possibility of water hammer which may cause damage to the pipeline or the valve.

The TKD offers an optional locking mechanism that prevents unintentional rotation. A padlock can be installed through the handle as an additional safety precaution.

Please contact IPEX customer service and technical support with regard to any concern not addressed in this data sheet or the technical manual.



About IPEX

IPEX is a leading supplier of thermoplastic piping systems. We provide our customers with one of the largest and most comprehensive product lines. All IPEX products are backed by over 50 years of experience. With state-of-the-art manufacturing facilities and distribution centers, the IPEX name is synonymous with quality and performance.

Our products and systems have been designed for a broad range of customers and markets. Contact us for information on:

- PVC, CPVC, PP, FR-PVDF, ABS, PEX and PE pipe and fittings (1/4" to 48")
- Industrial process piping systems
- Double containment systems
- Acid waste systems
- High purity systems
- Industrial, plumbing and electrical cements
- Municipal pressure and gravity piping systems
- Plumbing and mechanical pipe systems
- Electrical systems
- Telecommunications systems
- Irrigation systems
- PE Electrofusion systems for gas and water
- Radiant heating systems

WARRANTY: All IPEX products are guaranteed against defects resulting from faulty workmanship or materials. If any such product is found to be defective by reason of faulty workmanship or materials, upon written notice and return of the product, the defective product will be replaced by IPEX free of charge, including shipping charges for the replacement product. Claims for labour costs and other expenses required to replace such defective product or to repair any damage resulting from the use thereof will not be allowed by IPEX. Our liability is limited to the price paid for the defective product. IPEX will not be bound by any warranty, other than the above set forth, unless such warranty is in writing.

This literature is published in good faith and is believed to be reliable. However, it does not represent and/or warrant in any manner the information and suggestions contained in this brochure. Data presented is the result of laboratory tests and field experience.

A policy of ongoing product improvement is maintained. This may result in modification of features and/or specifications without notice.